

ELEGANT
LIGHTING

by MTM

ITEMS CATALOG 2024

Unique global
manufacturer and
leader of lighting

www.elegant-lighting.org



F01



F03



F05



F08



F10



F16



F20



F21



F25



F30



F31



F33



F47

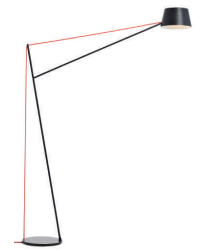

F48



F49



F80



F93



F94



F135



Electrical Characteristics:

💡 3 x LED bulb E14, 4 x LED bulb E27

⚡ 100-240V 50/60 Hz

⚙️ Power: 56W

🔌 Switch on the cable

📏 Height adjustable YES

Materials:

Shade: Steel

Base: Steel

Vertical tube: Steel

Certificates:



175 cm

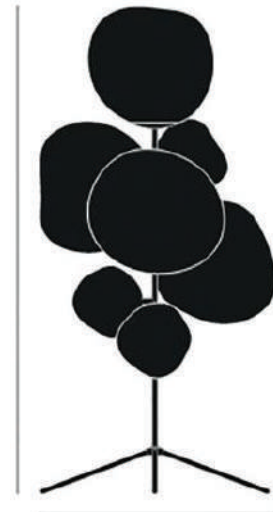

87 cm



BLACK



WHITE



GREY



GOLDEN



Electrical Characteristics:

- 💡 LED SMD 2835
- ⚡ Voltage: 180-240V 50/60 Hz
- ⚙️ Power: 8W 880Lm
2800-6000K
- 🕸️ Switch on the cable
- 📏 Height adjustable: YES
175cm max
135cm min

26 cm



173 -
175 cm

24 cm

Materials:

Shade : Steel

Base : Steel

Certificates:



BLACK



WHITE



GREY



**Electrical
Characteristics:**

- 💡 1xLED BULB E27
- ⚡ 100-240V 50/60 Hz
- ⚙️ Power: 5W 3000-6000K
- 🔘 Switch on the cable
- 📏 Height adjustable NO

Materials:

- Shade: Glass
- Body: Steel

Certificates:

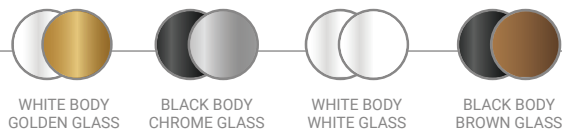
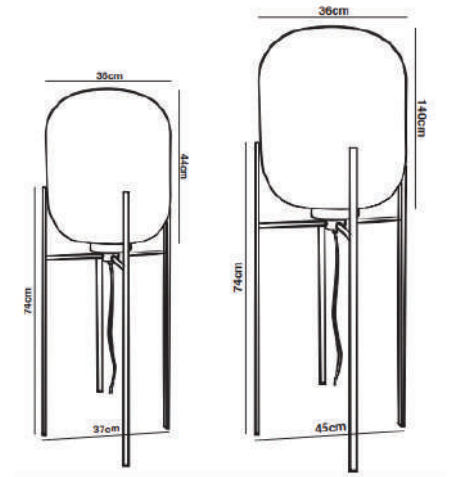

Product family:

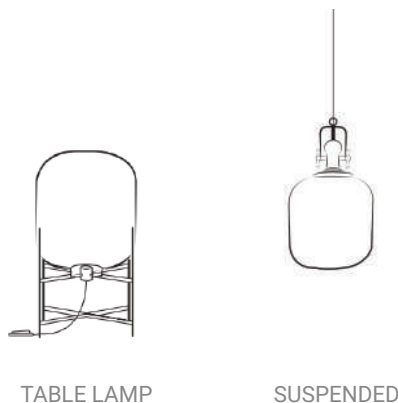

TABLE LAMP

SUSPENDED



**Electrical
Characteristics:**

- 💡 LED SMD 2835
- ⚡ 160-240V 50/60 Hz
- ⚙️ Power: 8W 880Lm
2800-6000K
- 🕸️ Switch on the cable
- 📏 Height adjustable NO

Materials:

- Shade: Glass
- Head: Aluminum
- Vertical tube : Stainless steel
- Base : Steel
- Base cover : Stainless steel

Certificates:

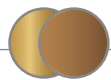
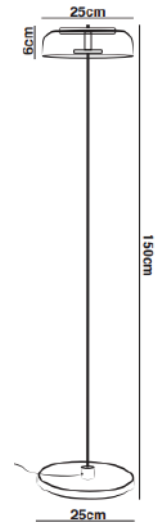

GOLDEN BODY
BROWN GLASS



CHROME BODY
CHROME GLASS



BLACK BODY
CHROME GLASS

Product family:



TABLE LAMP



SUSPENDED



WALL LAMP



Electrical Characteristics:

- 💡 3xLED BULB E14
- ⚡ 100-240V 50/60 Hz
- ⚙️ Power: 5W 3000-6000K
- 🔌 Switch on the cable
- || Higher adjustable NO

Materials:

- Shade: Glass
- Base: Steel
- Base cover: Stainless steel
- Vertical tube: Stainless steel

Certificates:

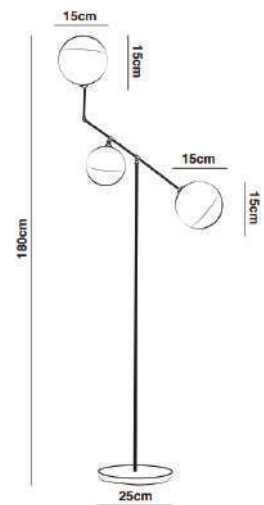

Product family:



CHROME

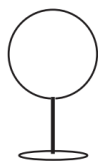

TABLE LAMP



SUSPENDED



WALL LAMP

F10



Electrical Characteristics:

- 💡 LED SMD 2835
- ⚡ 100-240V 50/60 Hz
- ⚙️ Power: 40W Max
- 5200Lm 2800-6000K
- 🔘 Switch on the cable
- || Heigher adjustable YES

Dimmerable: YES

Materials:

- Head: Aluminum
- Base: Steel
- Vertical tube: Steel

Certificates:

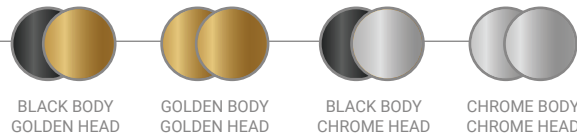
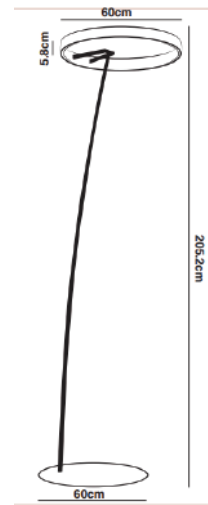

Product family:

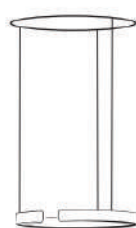

SUSPENDED



CEILING LAMP



Electrical Characteristics:

- 💡 1x LED BULB E27
- ⚡ 100-240V 50/60 Hz
- 🔌 Switch of home switcher
- 📏 Height adjustable YES
- 📏 Cord length: max to 150 cm

Materials:

Shade : Steel

Base : Steel

Certificates:

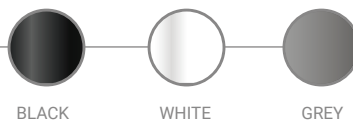
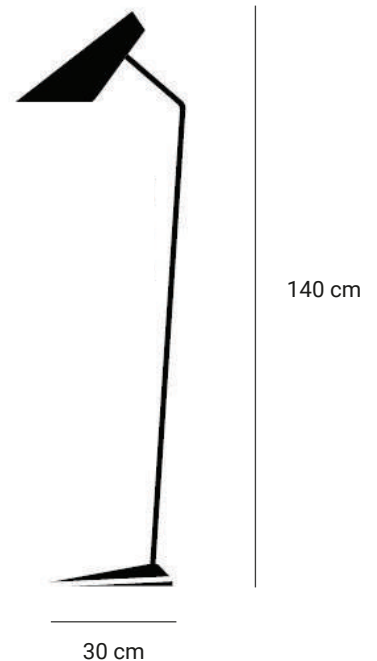



Electrical Characteristics:

- 💡 1xLED BULB E27
- ⚡ 100-240V 50/60 Hz
- ⚙️ Power: 9W 3000-6000K
- 🔘 Switch on the cable
- 📏 Height adjustable NO

Materials:

- Shade: Glass
- Base: Steel
- Vertical tube: Steel

Certificates:

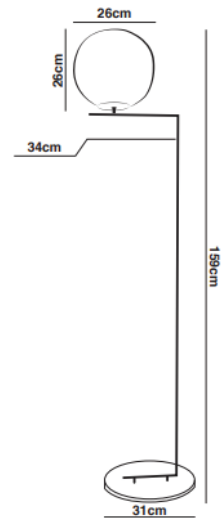

GOLDEN BODY
WHITE HEAD



BLACK BODY
WHITE HEAD



CHROME BODY
WHITE HEAD

Product family:

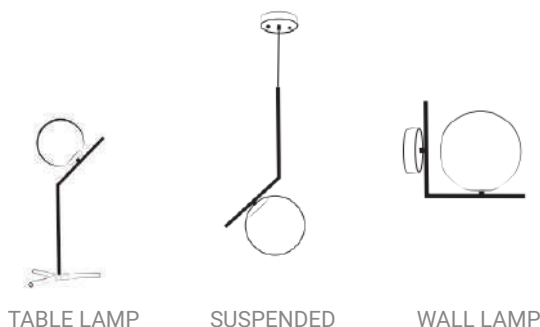
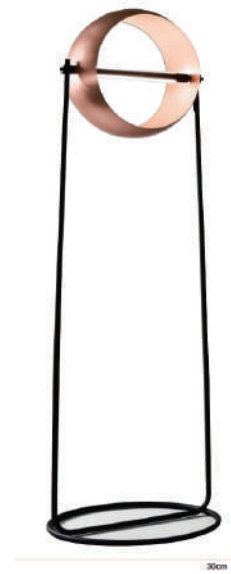

TABLE LAMP

SUSPENDED

WALL LAMP



Electrical Characteristics:

- 💡 LED SMD 2835
- ⚡ 160-240V 50/60 Hz
- ⚙️ Power: 12W 1440Lm
2800-6000K
- 🕸️ Switch on the cable
- 📏 Height adjustable YES

Materials:

- Body: Steel
- Shade: Aluminum

Certificates:

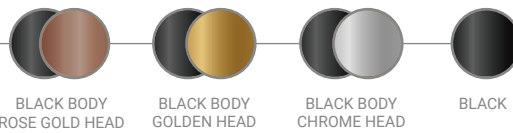

Product family:



TABLE LAMP



Electrical Characteristics:

- 💡 LED SMD 2835
- ⚡ 180-240V 50/60 Hz
- ⚙️ Power: 10W 1100Lm
2800-6000K
- 🕸️ Switch on the cable
- 📏 Height adjustable NO

Materials:

- Shade: Glass
- Head: Aluminum
- Base: Steel
- Base Cover: Stainless Steel
- Vertical tube: Stainless steel

Certificates:

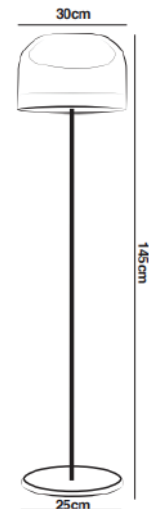

Product family:



TABLE LAMP



SUSPENDED



**Electrical
Characteristics:**

- 💡 LED SMD 2835
- ⚡ 100-240V 50/60 Hz
- ⚙️ Power: 18W 1880Lm
2800-6000K
- 🕸️ Switch on the cable
- 📏 Height adjustable NO

Materials:

- Body: Aluminum
- Base : Zamak
- Base cover : Steel

Certificates:



BLACK



WHITE

Product family:



TABLE LAMP

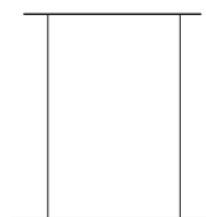

SUSPENDED



Electrical Characteristics:

- 💡 2xLED Bulb E14
- ⚡ 100-240V 50/60 Hz
- ⚙️ Power: 5W 3000-6000K
- 🕸️ Switch on the cable
- 📏 Height adjustable NO

Materials:

- Shade: Glass
- Base Cover: Steel
- Base: Steel
- Vertical tube: Steel

Certificates:

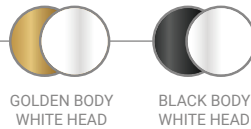

Product family:

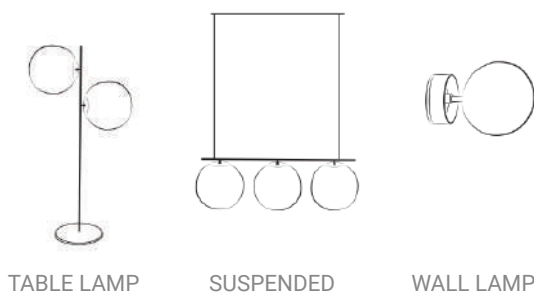



Electrical Characteristics:

💡 1xLED Bulb E14

⚡ 100-240V 50/60 Hz

⚙️ Power: 5W 3000-6000K

🔘 Switch on the cable

📏 Higher adjustable YES

Materials:

Head: Steel

Body: Steel

Certificates:

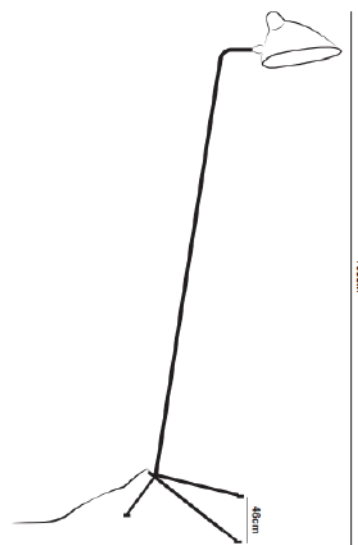

BLACK



WHITE



GREY

Product family:



TABLE LAMP



SUSPENDED



SUSPENDED (2)



SUSPENDED (3)



SUSPENDED (4)



WALL LAMP (1)



WALL LAMP (2)



**Electrical
Characteristics:**

- 💡 1xLED BULB E27
- ⚡ 100-240V 50/60 Hz
- ⚙️ Power: 9W 3000-6000K
- 🕸️ Switch on the cable
- 📏 Height adjustable YES

Materials:

- Shade: Steel
- Body: Steel
- Base: Steel

Certificates:

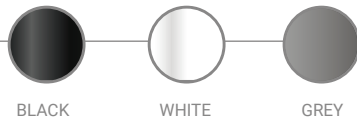

Product family:

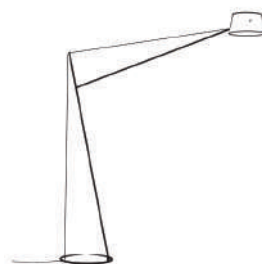
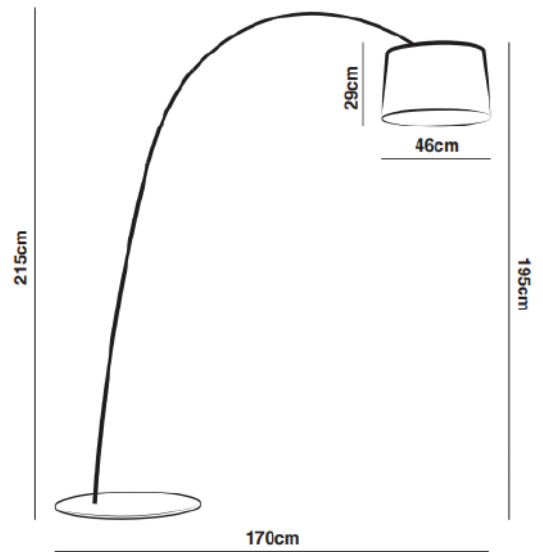

TABLE LAMP



Electrical Characteristics:

- 💡 1xLED BULB E27
- ⚡ 100-240V 50/60 Hz
- ⚙️ Power: 9W 3000-6000Kv
- 🕸️ Switch on the cable
- 📏 Height adjustable NO



Materials:

- Shade: Fabric
- Body: Steel
- Base: Steel

Certificates:

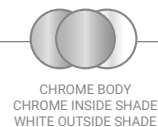
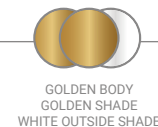
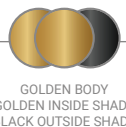
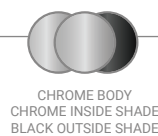
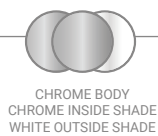
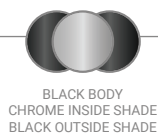



Electrical Characteristics:

- 💡 3xLED BULB E14
- ⚡ 100-240V 50/60 Hz
- ⚙️ Power: 7W 3000-6000K
- 🔌 Switch on the cable
- 📏 Higher adjustable YES

Materials:

- Head: Steel
- Body: Steel

Certificates:

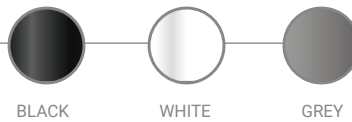
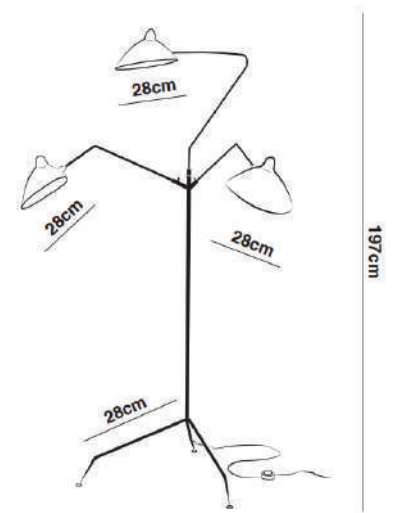

Product family:

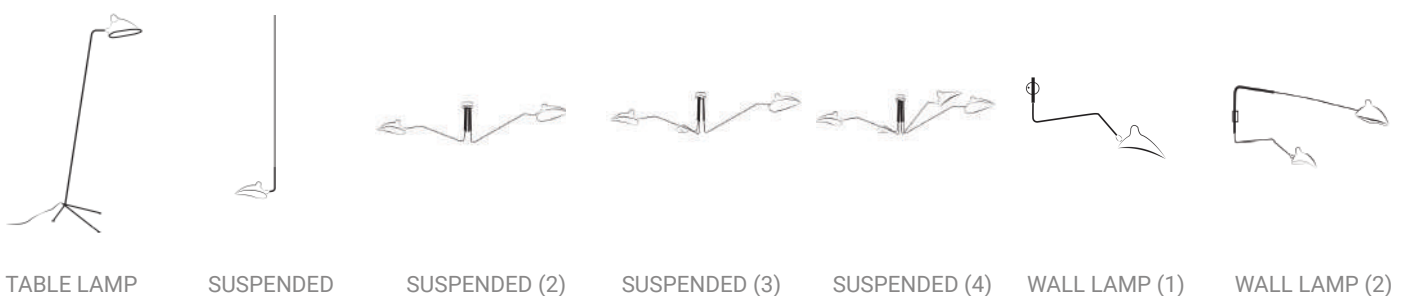

TABLE LAMP

SUSPENDED

SUSPENDED (2)

SUSPENDED (3)

SUSPENDED (4)

WALL LAMP (1)

WALL LAMP (2)



Electrical Characteristics:

- 💡 1x LED BULB E27
- ⚡ 100-240V 50/60 Hz
- 🔌 Switch on the cable
- 📏 Height adjustable NO

Materials:

- Shade : Acrylic
- Vertical tube : Stainless steel
- Base : Steel
- Base cover : Stainless steel

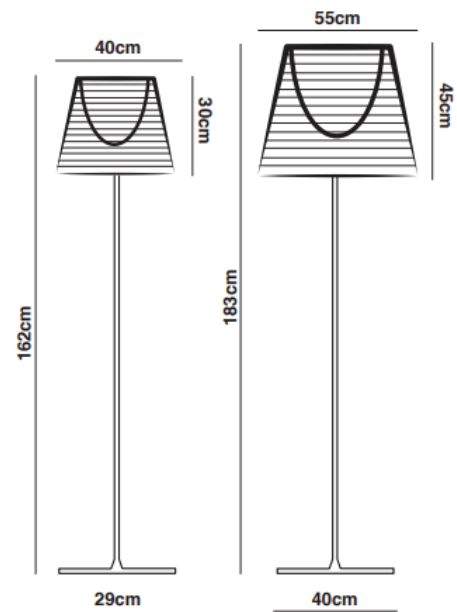

Certificates:

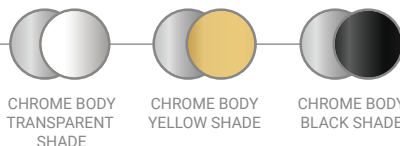



Electrical Characteristics:

- 💡 1x LED BULB E27
- ⚡ 160-240V 50/60 Hz
- 🕸 Switch on the cable
- 📏 Height adjustable NO

Materials:

- Shade : Steel
- Vertical tube : Steel
- Base : Steel
- Base cover : Steel

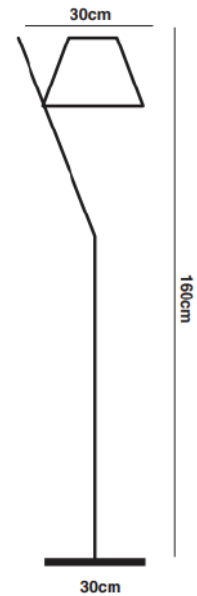

Certificates:

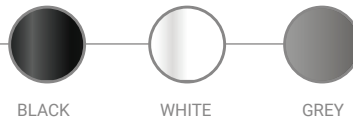

Product family:



TABLE LAMP



WALL LAMP



Electrical Characteristics:

- 💡 LED SMD 2835
- ⚡ 100-240V 50/60 Hz
- ⚙️ Power: 5W 3000-6000K
- 🔌 Switch on the cable
- 📏 Height adjustable

Materials:

- Shade: Stainless steel
- Base: Stainless steel

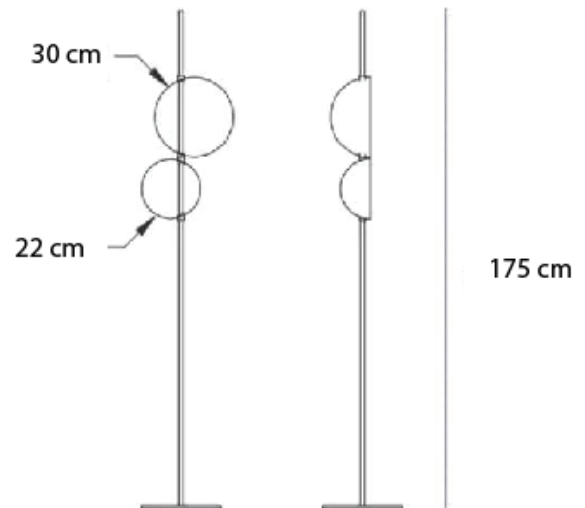

Certificates:

IP20

CE

LED

✓ RoHS

F



GOLD